



USER MANUAL

CELLULAR TRAIL CAMERA

Models:

LINK-DARK

LINK-DARK-V *(Verizon - USA ONLY)*

 support.spypoint.com

 1-888-779-7646

 support@spypoint.com
www.spypoint.com

v1





THANK YOU FOR CHOOSING A SPYPOINT PRODUCT.

This manual will guide you through all the features of your device so that you will get optimal use out of your SPYPOINT product. We strive on offering all customers a positive, user-friendly experience that will have a lasting impression.

JOIN THE SPYPOINT COMMUNITY

 facebook.com/SPYPOINT

 twitter.com/SPYPOINTcamera

 youtube.com/SPYPOINTtrailcam



ABOUT US

Our passion and commitment to the hunting industry has highly contributed to our success story. We are very proud of the path our home-grown company has taken and very grateful for every opportunity we have had. Quality, personalized service and support were the foundation for us and we continue to pursue this rule of thumb as our business grows.

Team work is the main focus at SPYPOINT and is also the key to our innovations and constant progress. A company is only as successful as its communication and team efforts. We are forever thankful to the team that supports us on a daily basis but, furthermore, we are honoured to have such talented and committed individuals to call our SPYPOINT family.

Components	4
Specifications	
LINK-DARK & LINK-DARK-V	6
Power	7
Memory/SD card & Busy LED	8
Settings	9
SPYPOINT LINK App	13
Installation & Mounting bracket	14
File transfer to a computer	15
Available accessories	16
Troubleshooting	17
Warranty & Repair	19
Regulation	20



- 1 Antenna
- 2 LEDs
- 3 Photo lens
- 4 Day and night sensor
- 5 Viewing screen
- 6 Detection lens
- 7 Test light
- 8 Navigation buttons
- 9 ON / OFF Switch
- 10 SD card inserts
- 11 Battery compartment & Micro SIM card inserts
- 12 Strap installation grooves
- 13 Locking latch
- 14 Cable lock holes
- 15 12V jack
- 16 Microphone
- 17 Tripod mount
- 18 Battery door push button



Components

1	Antenna	Allows cellular wireless communication.
2	LEDs	Night lighting to obtain black and white photos and videos. 42 invisible LEDs
3	Photo lens	Image sensor and infrared filter.
4	Light sensor	Detects the lighting conditions: color by day and infrared by night.
5	Viewing screen	Allows you to access the main menu and view photos/videos.
6	Fresnel lens	Expands the detection zone and increases the sensitivity of the camera's motion sensor.
7	Test light	Flashes in TEST mode when there is detection and flashes 30 seconds before entering in PHOTO/VIDEO mode to notify you to leave without being photographed or recorded.
8	Navigation buttons	Buttons to set the camera.
9	On-Off Switch	Allows the user to turn on/off the camera.
10	MEMORY/SD card inserts	An MEMORY/SD card is required to record photos/videos.

11	Battery compartment	AA batteries / Lithium pack compartment
	Micro SIM card inserts	A micro SIM card is required for cellular functions. (included) The camera will not work with a different SIM card then the one provided by Spypoint.
12	Strap installation grooves	Allows you to install the camera using the installation strap included.
13	Locking latch	Gives acces to the camera front control pannel. Once locked it seals the camera to protect it from weather and external elements.
14	Cable lock hole	Allows you to install a CL-6FT cable lock, sold separately.
15	12V power jack	This camera can be powered from an external 12-volt DC input such as a 12V battery or a 12V adapter, each sold separately.
16	Microphone	Records sound in video mode.
17	Tripod mount	Standard ¼-20" tripod mount.
18	Battery door push button	Allows you to access the battery compartment.

LINK-DARK & LINK-DARK-V

Cellular transmission

Frequency	LINK-DARK: 4G LTE LINK-DARK-V: 4G LTE (Verizon network)
Photo transmission	Wireless photo transmission via the free, SPYPOINT LINK App with a SPYPOINT plan. For more information, visit the link below. WWW.SPYPOINT.COM/PLANS
Configuration	Configurable from the settings menu of the camera. Also remotely configurable via the free SPYPOINT LINK app.

Photo recording

Photo resolution	cell OFF mode High: 12 MP cell OFF mode Normal: 2 MP cell ON mode High: 10 MP cell ON mode Normal: 2 MP
Software 48 MP	48 MP
File format	JPG
Time lapse mode	Intervals from 3 min to 24h
Multi-shot mode	Up to 3 photos per detection
Stamp	Date, time, temperature (°C/°F) and moon phase
Capture mode	Color by day, infrared by night

Video recording

Video resolution	1920 x 1080 (HD 1080p)
File format	AVI
Sequence length	Adjustable from 10s/30s/60s/90s
Stamp	Date, time, temperature (°C/°F) and moon phase
Capture mode	Color by day, infrared by night

Audio

Sound recording (automatically recorded in video mode)	Mono
--	------

Memory storage

Capacity	<ul style="list-style-type: none"> •Internal memory: none •External memory : standard full size SD/SDHC (up to 32 GB) (Not include)
----------	---

Viewing

Built-in screen	ACL 2.0"
-----------------	----------

Optional power sources

Alkaline or lithium batteries	8 x AA
Lithium battery pack	Rechargeable battery pack (LIT-09/LIT-C-8)
External (12V jack)	12V battery (KIT6V-12V, KIT-12V, BATT-12V) or 12V adapter (AD-12V)

Detection system

Motion sensor	PIR
Detection angle	45°
Detection distance	Up to 90' ft.
Trigger speed	0.07 sec
Delay between each detection	Adjustable from Instant to 30 min

Night time illumination system

LEDs	42 LEDs
Flash range	Up to 100 ft
Exposure	Automatic infrared level adjustment

Optical field of view

40°

Dimensions

3.8" W X 6.9" H X 3.9" D

Recommendations

Operating temperature	(-30 °C to + 50 °C) (-22 °F to +122 °F)
Storage temperature	(-40 °C to + 60 °C) (-40 °F to +140 °F)

POWER SOURCES

AA BATTERIES

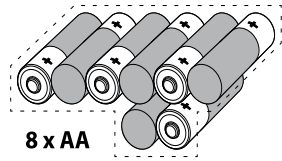

This camera can be powered by 8 AA batteries (1.5V). The use of alkaline or lithium batteries is recommended.

 To ensure maximum performance of the camera and prevent battery leaks, we recommend the use of new batteries. Make sure to insert each battery with the correct polarity. (Negative or flat end against the metal spring plate) Do not mix battery type - use ALL alkaline or ALL lithium. Do not mix old and new batteries. Rechargeable AA batteries are not recommended as the lower voltage provided can cause operational issues.

LITHIUM BATTERY PACK

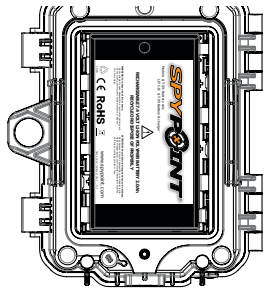

This camera can be powered by a rechargeable lithium battery pack LIT-09/LIT-C-8 (sold separately). This type of battery is less affected by cold temperatures and lasts up to 2 times longer than alkaline batteries.

EXTERNAL (12V)

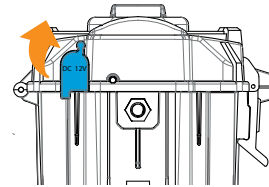

This camera can also be powered by an external 12-volt DC input such as a 12-volt battery (KIT-12V, BATT-12V or KIT6V/12V) or a 12-volt adapter (AD-12V), sold separately. It is impossible to use a solar panel directly plugged in the 12v. jack. The camera is not built to take charge of that kind of power supply. The use of a solar panel directly in the camera will not recharge or keep charge of any AAs or the lithium pack, at all. In order to use a solar panel, this one needs to be combined with the use of a 12v. battery as it needs to be plugged in the 12v.

Memory/SD card & "Busy" light

MEMORY/SD CARD

A memory card is required to record photos and videos. The camera is compatible with SD/SDHC memory cards, up to 32 GB capacity (sold separately). The use of a MICRO SD card IS NOT recommended.

The screen displays "Insert Memory Card" when the camera is turned on and no memory card is used.

Here is a table of the approximate number of pictures and video length that can be recorded on different memory card capacities. Refer to those corresponding to the camera model accordingly.

Note: This SPYPOINT camera is equipped with continuous file recording. When the memory card capacity is full, the camera will continue to record photos or videos by deleting the first recorded files.

	4 GB	8 GB	16 GB	32GB
Photo				
12 MP	1600	3200	6300	12600
Video				
1280 x 720	40 min	1h20	2h40	5h20

INSERTING THE MEMORY CARD

Before inserting or removing a memory card, always turn off the camera to prevent loss or damage. Also make sure the switch on the side of the card SD card is set on unlock.

Insert a standard full-size SD/SDHC memory card (up to 32 GB capacity) in the SD card inserts, label side facing upward. The card is inserted correctly when a click is heard.



! We strongly suggest to slow format the SD card on a computer before use, even more if it has been used in another device. This will maximize the memory card capacity and compatibility.

REMOVING THE MEMORY/SD CARD

Lightly push the memory card into the camera once to pop it out and remove it.

BUSY LED

The BUSY light is located at the back of the camera, on the battery door itself. It is a diagnostic tool. It lights up when the camera starts, when the camera records a file and in TEST mode in same time as the test light (located in front of the camera). Once the camera gets to the end of the connection process, the BUSY light will light ON, solid, as the camera is recording a picture/video then go OFF and will light ON again as sending the information in your account.



Main Menu

Use the ▲ and ▼ buttons to navigate in the interface and modify the selection, the OK button to select and the ↵ button to return to the previous menu.

START CAMERA
Allows you to start the camera in either, **PHOTO**, **VIDEO** or **TIME LAPSE** mode. When a mode is selected, the test light in front of the camera will flash for 30 seconds and a countdown will appear on the screen to allow you to leave the area without being photographed.

DETECTION TEST
Allows to test the detection system of the camera. When the **DETECTION TEST** mode is selected, no photo or video is recorded. Walk perpendicularly in front of the camera. When the camera detects a movement, the busy light blinks to indicate that normally, a photo or video would have been recorded. If the system does not detect the movement, increase the detection distance using the "Sensitivity" option in the settings menu and revise the camera installation.

VIEW
Allows you to view or delete recorded photos and videos on the camera screen.



- 1 Selected photo / total number of photos
- 2 The play icon indicates that this element is a video
- 3 The outline indicates which photo is selected

Viewing on the camera screen:

When the **VIEW** mode is selected, the latest photos or videos recorded appears as thumbnails gallery on the screen. Press ▲ or ▼ to navigate this page, and press OK to view an enlarged picture. To view the next or previous one press ▲ or ▼. Press back to return to the thumbnail view.

When a large photo is open, press OK to view the different options available:

Play:	Allows you to play or pause the video on the screen (this option is available only for videos).
Zoom:	Allows you to zoom in or out.
Date and time:	Allows the user to view the date and time printed on the photo.
Protect:	Allows you to protect a photo or video to prevent it from being deleted by selecting "Erase All".
Erase:	Allows to erase the photo or the video appearing on the screen from the memory card.
Erase all:	Allows you to erase from the memory card all stored photos and videos, with the exception of protected files.
Format:	Allows to format the memory card and delete all protected photos and videos.
Exit:	Allows to exit the menu and return to the viewing screen.

SETTINGS

 Allows you to configure the different settings on the camera. From **PHOTO**, **VIDEO**, **TIME LAPSE**, **WIRELESS** or **GENERAL** settings.



PHOTO SETTINGS

Sets the options of the PHOTO mode.

Recommended settings

The camera can be configured for **in trail usage**. This situation usually presents low activity levels, fast subjects and a small number of photos is expected. These settings increase the chances of capturing animals that follow each other.

The camera can also be configured for **feeder's site usage**. This situation usually presents high activity level, slow subjects and a large number of photos is expected. These settings moderate the number of photos taken while capturing overall activity on the feeder's site.

Here is a table showing the suggested settings for each situation:

	Trail	Feeder
Delay	Instant	5 min
Multi-shots	1	2-3

 When these recommended settings are not adapted to the situation, battery life can be affected.

Delay: (Instant/10s/1m/3m/5m/10m/15m/30m)

Allows you to choose the time interval between each detection before the camera records the next photo. A longer delay minimizes the number of photos taken and maximizes the battery life. A shorter delay maximizes the number of photos taken but requires more battery power. A shorter delay interval is recommended when the camera is used for security purposes.

Multi-shot: (1/2/3 consecutive shots)

Takes up to 3 consecutive shots at each detection, with a 5-second delay between each photo. This option allows the user to get up to 3 photos when the camera is set in PHOTO mode.



TIME LAPSE SETTINGS

Sets the options of the TIME LAPSE mode.

Interval: (From 3m to 24h)

Allows the camera to take photos at regular preset intervals. For example, if "5m" is selected in the TIME LAPSE mode, the camera takes a photo every 5 minutes. This option will disable the detection.

Note: The TIME LAPSE mode only applies for photos, not videos. When the TIME LAPSE mode is selected, the DELAY option and the MULTI-SHOT mode are disabled.



VIDEO SETTINGS

Sets the options of the VIDEO mode.

Delay: (Instant/10s/1m/3m/5m/10m/15m/30m)

Allows the user to choose the time interval between each detection before the camera records the next video. A longer delay minimizes the number of videos taken and maximizes the battery life. A shorter delay maximizes the number of videos taken but requires more battery power. A shorter delay interval is recommended when the camera is used for security purposes.

Video length: (10s/30s/60s/90s)

Allows the user to select the duration of the recording when the camera is set in VIDEO mode.

Photo first: (On/Off)

When this option is enabled, a photo is taken immediately before each video.

Note: The file name of the photo corresponds to the digit before the video file name. For example, if the name of the photo is PICT001.JPG, the name of the video will be VID001.AVI. The video mode will record videos on the SD card but will not transfer them to your account. The Photo first option will send you the picture taken just before the video starts. In order to view those videos, you need to retrieve the SD card from the camera and read it from a computer.



WIRELESS SETTINGS

Sets the wireless options of the camera.

Cellular: (On/Off)

Allows to turn ON or OFF the transmission of pictures

Frequency:

Allows you to choose the number of transfers that the camera performs in a day, to send the pictures in the account. Note that the transfer frequency period is divided on a 24h period. It is important to note that this operation is battery consuming. Increasing the frequency will use more battery power.

First Transfer time:

Allows to choose at what time of the day the camera communicates for the first time. It is setting your camera to communicate once a day with your account, even if there are no pictures, so you will get the status and see that the camera is still working.) It also sets the first time frame for the transmission frequency.

GPS: (On/Off)

Allows the camera to send GPS coordinates while it communicates accordingly with the chosen settings and plan.



GENERAL SETTINGS

Sets the general options of the camera.

Language: (English/Français/Deutsch)

Allows to select a language for the camera menus.

Date format: (MM/DD/YY, DD/MM/YY)

Allows to set the date as Month/Day/Year or as Day/Month/Year.

Time format: (12H/24H)

Allows to set to standard time or military time.

Date:

Allows to set the date

Time:

Allows to set the time

Sensitivity: (Low/Medium/High)

Allows to choose the sensitivity of the motion sensor.

The camera will only detect sources of heat in motion. Make sure to have the least possible objects in front of the camera during the positioning. This prevents the camera from taking photos when oriented towards the sun while an object is moving in front of the camera. (e.g. a branch, foliage, reflection of the sun on water or snow.)

Quality: (Normal/High)

Allow to set the photo quality. (2MP/12MP)

Schedule

Allows you to set the working period of the camera for each day of the week. The start and stop time are the hours during which the camera is in action and can record pictures or videos. For a continuous 24/7 operation, Start and stop time should be the same, such as 00:00 or 12 am /12 am.

Note: The hours can be recorded over a 12 or 24-hour period. Refer to the «Time format» option.

Battery type: (AA/LIT-09/12V)

Allows the user to select the battery type in use to get a more precise battery level reading

Info on photos: (Yes/No)

Allows to have date, time, temperature and moon phases on the photos.

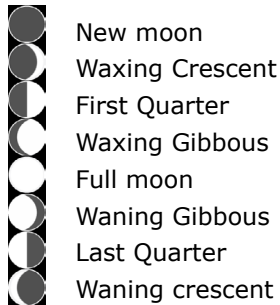

Night mode:

Allows to set the best option for night mode photos.

	OPTIMAL MODE	IR-BOOST MODE	BLUR REDUCTION MODE
Battery life	★★★★★	★★★★★	★★★★★
Flash range	★★★★★	★★★★★	★★★★★
Blur reduction	★★★★★	★★★★★	★★★★★

* Available for photos only

Temp. units: (°C/°F)

Allows to select the temperature display.

About the device:

Allows the user to display system information:

- Software version number
- Hardware version number
- Model
- SIM card number
- & more.

Factory reset:

Allows to reset the device configurations to its original state.

Login in the SPYPOINT LINK app, gets you directly on the Photos tab. From there, you'll see the latest photos received, sorted by date & time.

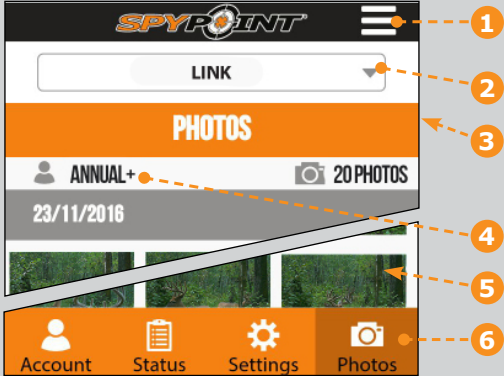

The screenshot shows the app's main interface. At the top is the 'SPYPOINT' logo and a menu icon (1). Below is a search bar labeled 'LINK' (2). The main section is titled 'PHOTOS' (3) and shows a user profile 'ANNUAL+' with a camera icon and '20 PHOTOS'. Below that is the date '23/11/2016' (4) and a photo gallery (5). At the bottom is a navigation bar with icons for 'Account', 'Status', 'Settings', and 'Photos' (6).

- 1 **Menu:** Read messages, set the notifications, language, login.
- 2 **Camera name:** Select the camera you want to view or setup.
- 3 **Current tab:** Indicate in what tab section you currently are.
- 4 **Plan:** Current plan.
- 5 **Photos:** Photo gallery sorted by date & time.
- 6 **Tab selection:** Select the tab section you want to consult.

ACCOUNT
Select and subscribe to a Data plan, modify your profile information.

DATA PLAN
4 Plans are available: "Annual" and "Annual+" running for 12 months each, and "Hunting" plan for 3 months. If you choose not to activate a plan, note that you'll still be able to receive pictures, under the FREE plan. Allowing you to receive up to 100 photos /month with a photo history of the last 7 days.

MODIFY YOUR PROFILE INFORMATION
Modify your profile, Name, Address, Phone number & more.

STATUS
Show camera's information, transferred in the last communication.

LEVELS

Consult camera signal strength, battery level, SD card used space & more.

GENERAL INFORMATION

Gives information on the model, version, last communication, amount of pictures transferred this month, temperature and battery type readings.



SETTINGS

Modify the camera settings, synchronization frequency & others.

BASIC Mode - PHOTO

Set Delay, Multi-shot, Sensitivity & Camera name.

Mode - TIME LAPSE

Set Interval and camera name.

Mode - VIDEO

Set Delay, Sensitivity, Photo first & Video length.

CELLULAR SETUP

Set Cellular transmission, First transfer time & frequency, Take a photo at next transfer.

ADVANCED OPTIONS

Set the Date format, Temp. unit., Night mode and Schedule.

OTHER OPTIONS

Report camera stolen, Disable BUCK TRACKER.

WIRELESS SETUP OF THE LINK CAMERA

- Note that any modification of the settings through the app will carry over to the camera at the end of the next synchronization.
- Settings in the App are the same one as in the camera.
- Once in the app, if you don't recall what function a setting is for, you can fast touch the setting and an information tag will appear.



PHOTOS

Photo gallery, sorted by date, months and years. It also lets you share, download and erase your pictures.

- Scroll up or down to view your photos by date.
- Touch tap on a photo to select it and enlarge it.
 - Swipe left to see previous one or right for the next one.
 - Click on the arrow top right of the screen to share the photo.
 - Keep your finger on a photo to be able to delete it from the App.
 - Swipe up or down to return to the PHOTOS tab & refresh the screen.

Installation & Mounting bracket

LINK-DARK

INSTALLATION

Recommended installation height:

Camera should be installed to aim the animal's mid-body.

Ideal installation for quality pictures & videos:

For a better field of view, the targeted animal should be ranged at a 25 feet / 7.5m distance away from the camera.

To get brighter pictures at night, it is important to consider having background elements to reflect the camera's infrared. (e.g. Trees or fence)

Make sure the front of the camera is free of any obstructions. The installation area should be cleared from branches or bushes. These could be responsible for triggering false detections when combined with heat, reflections and/or wind. Setting the sensitivity level of the camera too high can also result in false detections.

DETECTION/TRIGGER ZONE

In order to get the best detection zone coverage, you need to consider that the trigger zone is what will be displayed in the middle of a picture. The detection works on a flat level and will give better results if you consider side to side motion.

Here is an exemple of a proper installation. Every motion within the red rectangle will trigger the camera. Everything under or upper those limits will not. By looking at your photos you can see if the camera is aiming properly at the action path.

MOUNTING BRACKET

To remove the camera from the mounting bracket:

1. Push the tab to release the camera from the mounting bracket.
2. Remove the camera.



INSTALLATION WITH THE SUPPLIED STRAP

Use the mounting bracket or the camera strap installation grooves to fix the camera. The dimensions of the strap (included) is 1" X 60".

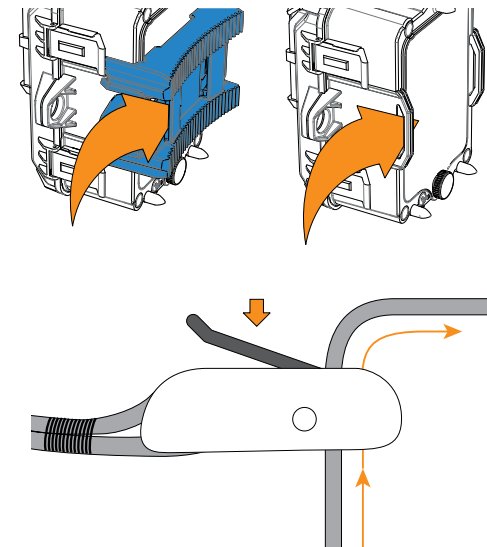

File transfer to a computer

To transfer photos/videos to a computer:

- Turn OFF the camera.
- Remove the SD card from the camera.
- Insert the SD card into the computer reader, or use a memory card adaptor.
- The computer will detect the card and install the driver automatically.



For a PC

Click on "My Computer" or «This PC» on your Desktop

Locate your device under "Removable Disk" and then click to access it. Then click on "DCIM" and "100DSCIM" to find all recorded photos and videos.

Select the photos you want to copy. The easiest way is to select them all by clicking on the Home tab and the Select all on the right-hand side. (You can also press Ctrl and the 'A' key, or click the Edit menu and choose select all in other versions of Windows)

Click the Copy icon on the left-hand side of the ribbon (or hold Ctrl and press C). [NOTE: If you don't want to select all photos, hold down the Ctrl key and click on the photos you do want to select before clicking the Copy icon]

Navigate to the folder in which you would like to store your images, or create a new folder by clicking the New Folder button in the ribbon. (You can also press Ctrl-Shift-N together to create a new folder, or right-click in some empty space in the Pictures folder and choose New, then from the next menu: Folder)

Type a name for your new folder, press Enter and then double-click on the folder to open it.

From the Home tab, choose Paste (or hold Ctrl and press V). The photos will be copied into the new folder.

For a Mac

Click the Finder icon in the Dock.

Locate your device under the Devices tab and then click to access it. Then click on "DCIM" and "100DSCIM" to find all recorded photos and videos.

Click Edit on the toolbar running along the top of the screen and then press Select All to highlight every single image on the device. Select All is also achievable by pressing the ⌘ and A key simultaneously on your keyboard.

Alternatively, if you do not wish to import all, you can individually highlight the images you would like to transfer by holding ⌘ and clicking the file-name.

Click Edit once again and then Copy (or ⌘ and C) to copy the highlighted images.

Navigate to the folder in which you would like to store your images, or create a new folder by right-clicking and pressing CTRL simultaneously, then select New Folder from the menu.

Click Edit and then Paste (or ⌘ and V) to copy your chosen images from your device to the selected folder.

Images may take several minutes to transfer depending on the file size and the amount of images you are importing.

Once your images have transferred, click the Eject icon situated alongside the name of your device and then unplug the device from your Mac.



Rechargeable 12V battery, charger & housing kit
#KIT-12V, 12-volt 7.0Ah rechargeable battery with a water resistant ABS plastic case, AC charger, 12 ft power cable



Lithium battery pack & charger
#LIT-C-8, Rechargeable lithium battery pack and AC charger with charge indicator light. Fits all SPYPOINT cameras.



12V DC Power cable
#CB-12FT, 12 ft power cable with alligator clips at one end to connect a 12V battery to a camera.



12-volt Adaptor
#AD-12V, AC adaptor (6V to 12V). Powers the camera from an electrical outlet.



Steel security box
#SB-200, Steel box to secure the camera against theft. It also protects it from breakage caused by bears or other animals. Fits all SOLAR 42 LED SPYPOINT cameras.

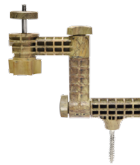

Camera mount
#MA-360, Adjustable mounting arm, fits all cameras that have a standard 1/4-20" tripod mount. It can rotate 360° and tilt approx +/- 90°. Also available in black.



Cable lock
#CL-6FT, 6 ft cable lock fits all SPYPOINT cameras.



SD Memory card 16GB
#SD-16GB, SDHC UHS-1 memory card 16 GB, ultra high speed Class 10.

 Steel security boxes may reduce the wireless functionalities of the product.



Long range cellular antenna
#CA-01, External omnidirectional antenna to amplify the cellular signal. Cable length of 16 ft with male RP-SMA connector.



Solar panel
#SP-12V, Maintains the charge of the lithium battery pack directly into the compatible cameras. Can be combined with any 12V battery.

To obtain more information on other available accessories, we invite you on our web site at:

www.spypoint.com

Issue	Possible solutions
Impossible to turn on the camera	<ul style="list-style-type: none"> • Verify if there are batteries in the camera. • Verify if the batteries are correctly installed. • Replace batteries or recharge the lithium battery pack.
The screen of the camera turns off	<ul style="list-style-type: none"> • The camera may be set to PHOTO or VIDEO mode and the screen turns off after a period of 30 seconds in order to preserve battery life. • The camera automatically resets itself to PHOTO or VIDEO mode (along with the latest mode used or selected) after 2 minutes of inactivity on the main menu. • To get the screen back, turn off the camera and turn it on again.
The camera does not respond	<ul style="list-style-type: none"> • Remove the batteries and reinstall them. • Replace batteries or recharge the lithium battery pack.
Impossible to take photos/videos	<ul style="list-style-type: none"> • Verify if there are batteries in the camera. • Replace batteries or recharge the lithium battery pack. • Verify if the camera is turned on. • Slow format the memory/SD card in a computer. • Make sure the camera detects movement by proceeding to a Detection Test.
Red light in front of the camera blinks	<ul style="list-style-type: none"> • Camera is set on TEST mode. • Camera is set on PHOTO or VIDEO mode. The red light in front of the camera flashes for 30 seconds to allow the user to leave without being photographed or recorded.

Camera takes black photos / videos	<ul style="list-style-type: none"> • Verify the battery level to see if battery power is full as the flash will stop operating near the end of the battery life especially if you're doing a video. • Verify that there's something within the flash range to reflect the infrared back to the camera. • If you're unsure if the flash is working properly, test the camera in a dark room to see if you're able to have black & white pictures or videos.
Photos / videos appear dark at night	<ul style="list-style-type: none"> • For best results, make sure the subject is within the ideal flash range. Subjects may appear too dark at greater distances.
Photos are blurry	<ul style="list-style-type: none"> • Low lighting conditions and fast moving subjects, may produce streaks on the photo, try setting the "Night mode" to "BLUR" to reduce the motion blur.
No person/animal on photos	<ul style="list-style-type: none"> • Sunrise or sunset can trigger the sensor. Camera must be re-orientated. • At night, the motion detector may detect beyond the range of the IR illumination. Reduce sensitivity setting. • Small animals may trigger the unit. Reduce sensitivity setting and/or raise height of camera. • Motion detector may detect animals through foliage. • If a person or animal moves quickly, it may move out of the camera's field of view before the photo is taken. Move the camera further back or redirect the camera. • Make sure the mounting post or tree is stable and does not move.

Error message	Possible solutions
Insert memory card	The use of a memory/SD card is required to record photos and videos. Make sure to use a SDHC standard full size 32 GBs and less memory card. DO NOT use a MICO SD in an adaptor.
Card error	<p>The camera cannot access the memory card.</p> <ul style="list-style-type: none"> • Turn off the camera and turn it on again. • Turn off the camera, then remove the SD card and insert it again. The card is inserted correctly when a click is heard. • Verify if the gold contacts are clean. • Format the memory card. Slow format the memory/SD card in a computer.
Low battery	Appears on the screen just before the camera turns off. Replace batteries or recharge the lithium battery pack. Always verify the battery level before using the camera.
No image	<p>The camera does not display any pictures/videos.</p> <ul style="list-style-type: none"> • Verify if the SD card is not locked. • Verify if the memory card contains photos/videos with a computer. Make sure to use a standard full size 32GBs and less SD card. Do not unse a MICRO SD card in an adaptor.
Protected file	<p>The file you want to delete is protected.</p> <ul style="list-style-type: none"> • Unprotect the photo in the View mode, then you will be able to delete this file. • Format the memory card to delete the files.
Error: No SIM card	<p>The SIM card is missing or defective.</p> <ul style="list-style-type: none"> • Turn off the camera and turn it on again. • Turn off the camera, retrieve the SIM card and insert it again as shown on the drawing in the battery case. The card inserted correctly when a click is heard.

Error: SIM card	<p>The SIM card is defective.</p> <ul style="list-style-type: none"> • Turn off the camera and turn it on again. • Turn off the camera, then remove the SIM card and insert it again as shown on the camera. The card is inserted correctly when a click is heard.
Error: SIM locked	<p>Your SIM card is locked.</p> <ul style="list-style-type: none"> • Contact the SPYPOINT customer service.
Error: SIM locked (PUK)	<p>Your SIM card is locked and requires a PUK.</p> <ul style="list-style-type: none"> • Contact the SPYPOINT customer service.
Error: SIM card not supported	<ul style="list-style-type: none"> • The camera must use the SPYPOINT SIM card provided with the camera.
Error: No service	<p>The SIM card does not detect any signal.</p> <ul style="list-style-type: none"> • Get outside or near a window and restart the camera a few times if required to get all the information from the cell network. * If the signal is still too low, there is a possibility to get a Long range cellular antenna (CA-01), from our website.
Error: Modem	<p>There has been a communication problem between the camera and the modem.</p> <ul style="list-style-type: none"> • Turn off the camera and turn it on again.

SIT BACK, RELAX & KNOW YOU'RE COVERED



This SPYPOINT product designed by GG Telecom, is covered by a two (2) year limited warranty on material and workmanship starting from the original date of purchase. The electronic sales receipt is the client's proof of purchase and must be presented if warranty service is needed. This warranty will be honored in the country of purchase only.

This GG Telecom warranty does not apply to: (a) consumable parts, including but not limited to batteries, which performance is designed to decrease over the course of time; (b) damage caused by misuse, combined with another product, neglect, accidents, liquid contact, fire, earthquake or any other external cause; (c) GG Telecom products that have been purchased online from an unauthorized dealer; (d) products that have had any modification or tampering; (e) cosmetic damage including but not limited to scratches and broken plastic; (f) damage caused by operating the GG Telecom product outside of GG Telecom's recommendations.



YOUR PATIENT WITNESS

CAMERA TRAPS cc

+27(0)83 560 0555
+27(0)82 422 0356
info@cameratrap.co.za
www.cameratrap.co.za

INSTRUCTIONS FOR REPAIR SERVICE

GG Telecom will repair the product or replace it at its discretion with an equivalent product without charge if covered by the warranty described previously. The shipping fees for an item sent will be assumed by the customer. GG Telecom will then pay for the return of the product covered by the warranty.

For a product not covered by the warranty, the repair will be subject to a reasonable charge and the customer will also assume all shipping costs.

IMPORTANT: Under no circumstances will GG Telecom accept returned products without a RMA number. (Return Material Authorization) It is essential to contact GG Telecom before proceeding to a return.

1. Before sending a product for repairs, please contact GG Telecom technical support team by phone at : 1-888-779-7646, by email at support@spypoint.com, via LIVE CHAT from the app itself or on our website at www.spypoint.com, as most issues can be solved over the phone or by email.
2. If a product needs to be sent, a RMA number will be given to authorize the return of the product and for future reference.
3. The original receipt or a copy must be sent along with the package.
4. The RMA number must be written on the outside of the package and sent to:

CANADA
GG Telecom
120 J.Aurèle-Roux
Victoriaville, QC
G6T 0N5

UNITED STATE
GG Telecom
1825 E Army Post Rd,
Des Moines, IA 50320

The customer is liable for loss or damage to the product that may occur during the shipping to GG Telecom. We recommend the use of a traceable method of shipping to ensure protection.

WWW.SPYPOINT.COM

FCC REGULATIONS



FCC Part 15

This equipment has been tested and found to comply with the limits for a Class B digital device, pursuant to Part 15 of the Federal Communications Commission (FCC) rules. These limits are designed to provide reasonable protection against harmful interference in a residential installation. This equipment generates, uses and can radiate radio frequency energy and, if not installed and used in accordance with the instructions, may cause harmful interference to radio communications. However, there is no guarantee that interference will not occur in a particular installation. If this equipment does cause harmful interference to radio or television reception, which can be determined by turning the equipment off and on, the user is encouraged to try to correct the interference by one or more of the following measures:

- Reorient or relocate the receiving antenna.
- Increase the separation between the equipment and receiver.
- Connect the equipment into an outlet on a circuit different from that to which the receiver is connected.
- Consult the dealer or an experienced radio/TV technician for help.

Changes or modifications to this equipment not expressly approved by the party responsible for compliance could void the user's authority to operate the equipment. This device complies with Part 15 of the FCC rules. Operation is subject to the following two conditions: (1) this device may not cause harmful interference, and (2) this device must accept any interference received, including interference that may cause undesired operation.